

Varenummer: 20967503
Beskrivelse: E+G Justerfod
GN 343.7-60-M16-A

Mål

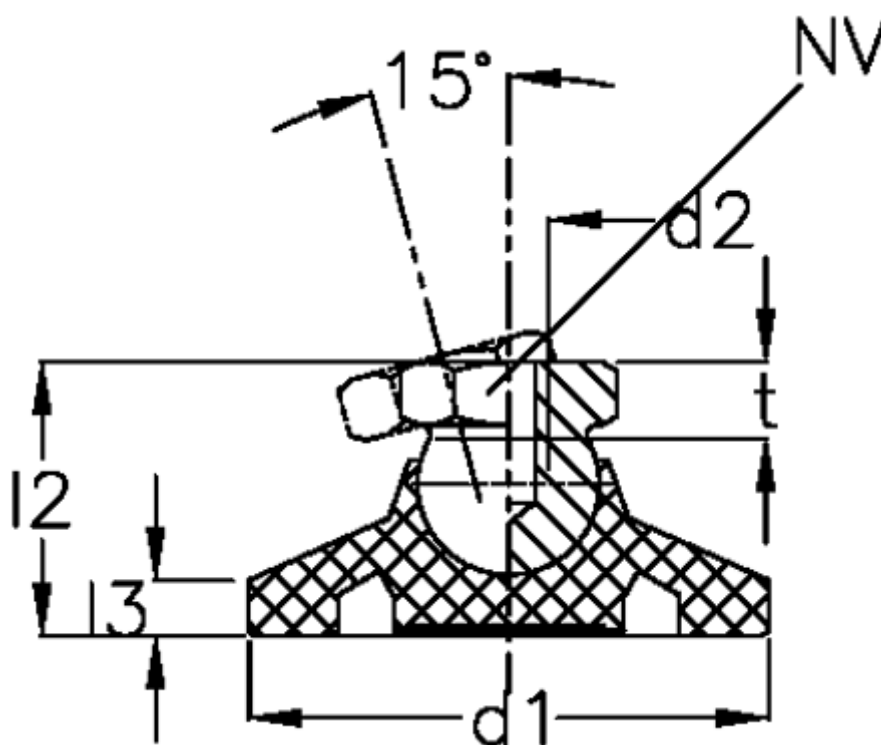

d_1	= 60
d_2	= M12
l_2	= 35.5
l_3	= 8.5
NV	= 17
Statisk belastning (N)	= 14000
t min	= 11.5